

AC Operated *

DC Operated *

XLS4K, XLS5K, XLS7K

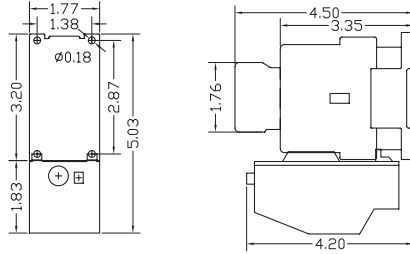

XLS4K, XLS5K, XLS7K

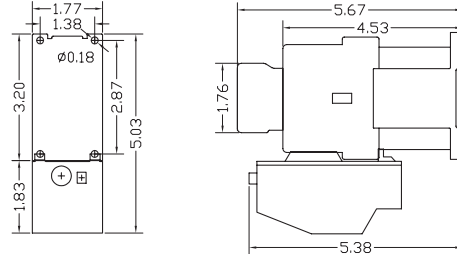

XLS11K

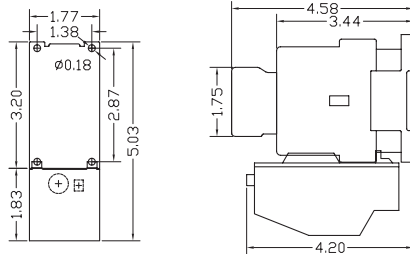

XLS11K

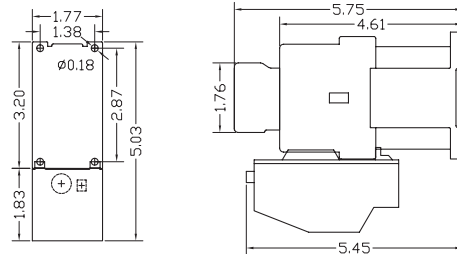

XLS15K, 18K

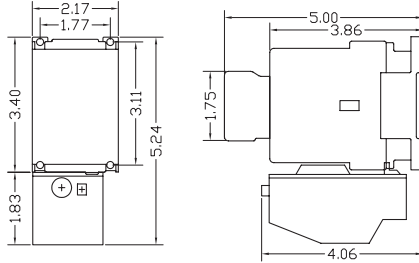

XLS15K, 18K

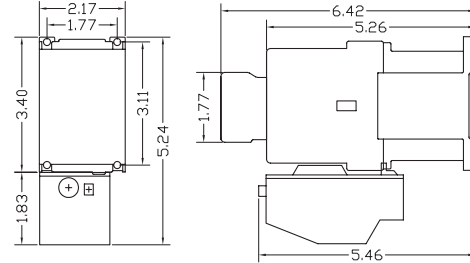

XLS22K, 30K, 37K

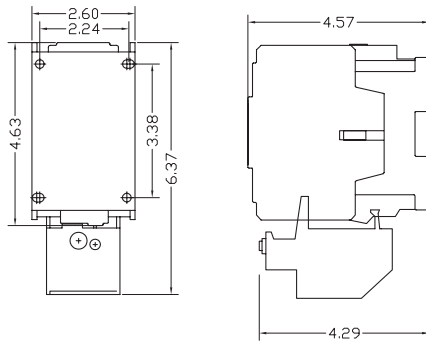

XLS22K, 30K, 37K

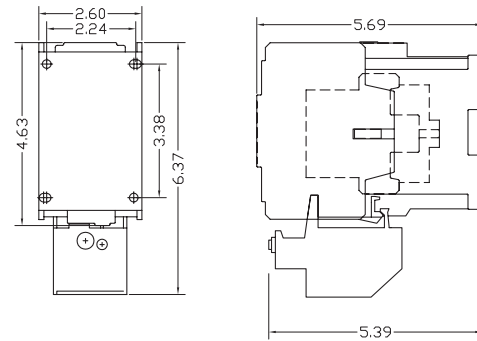

XLS45K, 55K

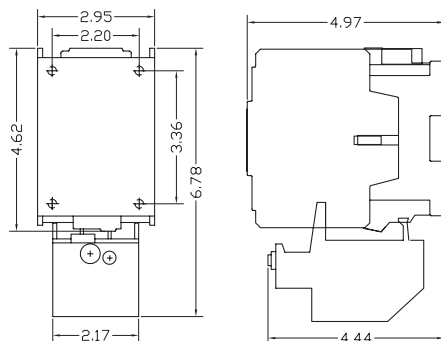

XLS45K, 55K

